



NextG Networks of California, Inc.

**MPC1035CA-GOLN002**

**GOLETA**

**GOLETA, CA 93117**



**RECEIVED**  
 AUG 17 2010  
 City of Goleta  
 Planning & Environmental Svcs.



1-800-227-2600  
 CALL AT LEAST TWO DAYS  
 BEFORE YOU DIG

UNDERGROUND SERVICE ALERT OF NORTHERN CALIFORNIA

TICKET # \_\_\_\_\_



PROJECT INFORMATION:

**MPC1035CA-GOLN002**  
**GOLETA**  
**GOLETA, CA 93117**

CURRENT ISSUE DATE:

**08/08/2010**

PERMIT SUBMISSION:

REV. DATE: DESCRIPTION: BY:

REV.	DATE	DESCRIPTION	BY

PLANS PREPARED BY:

**HP COMMUNICATIONS INC.**

5720 THORNWOOD DR.  
 GOLETA, CA 93117  
 PHONE: (951) 471-1919

PLANS APPROVED BY:



REP:

COMMENTS:

SHEET TITLE:

**TITLE SHEET**

SHEET NUMBER: REVISION:

**1**

**1 OF 6**

ALL WORK AND MATERIALS SHALL BE PERFORMED AND INSTALLED IN ACCORDANCE WITH THE CURRENT EDITIONS OF THE FOLLOWING CODES AS ADOPTED BY THE LOCAL GOVERNING AUTHORITIES. NOTHING IN THESE PLANS IS TO BE CONSTRUED TO PERMIT WORK NOT CONFORMING TO THE AREAS GOVERNING CODES.

1. STATE ADMINISTRATIVE CODE	5. STATE PLUMBING CODE
2. STATE BUILDING CODE	6. STATE ELECTRIC CODE
3. A/S/E/A-222-LIFE SAFETY CODE NFPA-101-1996	7. LOCAL BUILDING CODE
4. STATE MECHANICAL CODE	8. CITY/COUNTY ORDINANCES

**CODE COMPLIANCE**

**PROPERTY INFORMATION**

CUSTOMER: NEXTG NETWORKS OF CALIFORNIA, INC.  
 PROJECT: EAST SANTA BARBARA  
 NODE: MPC1035CA-GOLN002  
 LATITUDE: 34.42537  
 LONGITUDE: -119.87682  
 STREET ADDRESS: 1/4 E/C OF PACIFIC OAKS AND PHELPS RD.  
 CITY, STATE: GOLETA, CA 93117  
 JURISDICTION: CITY OF GOLETA  
 POLE#: NEW POLE  
 POLE TYPE: METAL POLE  
 PAD CENTER / ANTENNA HEIGHT: 27'-5"  
 ANTENNA TYPE: AWS360-1710-7-T0-N  
 AZIMUTH FOR ANTENNA: N/A  
 POWER TO POLE: SECONDARY  
 POLE ACCESS: ON ROAD  
 POLE OWNER: N/A  
 POLE LOCATION & DESCRIPTION: 1/4 E/C OF PACIFIC OAKS AND PHELPS RD.

**PROJECT SUMMARY**

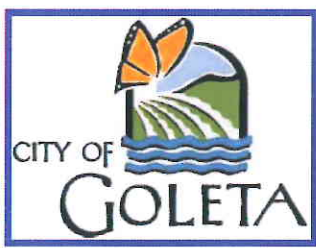

THE PROJECT CONSISTS OF THE INSTALLATION AND OPERATION OF ANTENNAS AND ASSOCIATED EQUIPMENT CABINETS FOR NEXTG. THE INSTALLATION OF GROUND MOUNTED EQUIPMENT CABINETS, ANTENNAS ON AN EXISTING STREET LIGHT, WOOD POLE, TRAFFIC SIGNAL AND NEW STEEL POLES.

**PROJECT DESCRIPTION**

INSTALL / PLACE NEW FIBER TO NEW OR EXISTING POLE. INSTALL EITHER OMNI OR PANEL ANTENNAS AND ALL ASSOCIATED BRACKETS IN ACCORDANCE TO CONSTRUCTION SPECIFICATIONS. REARRANGE ALL EXISTING FACILITIES IN ACCORDANCE TO GOVERNING CONSTRUCTION GUIDELINES.

**PROJECT SCOPE**

SHEET	DESCRIPTION	REV.
1	TITLE SHEET	2
2	NOTES	2
3	UTILITY NODE / REPEATER POLE EQUIPMENT PROFILES	2
4	MAPS	2
5	TYPICALS	2
6	TYPICALS	2

**SHEET INDEX**

**DO NOT SCALE DRAWINGS**

CONTRACTOR SHALL VERIFY ALL PLANS AND EXISTING DIMENSIONS AND CONDITIONS ON THE JOB SITE AND SHALL IMMEDIATELY NOTIFY THE ARCHITECT IN WRITING OF ANY DISCREPANCIES BEFORE PROCEEDING WITH THE WORK OR BE RESPONSIBLE FOR SAME.

**GENERAL CONTRACTOR NOTES**



ATTACHMENT B  
 CONDITIONS OF APPROVAL  
 NEXTG NETWORKS CONDITIONAL USE PERMIT AMENDMENT  
 CASE NO. 10-051-CUP AM  
 VARIOUS LOCATIONS WITHIN CITY RIGHTS-OF-WAY AND UTILITY  
 EASEMENTS ACROSS PUBLIC AND PRIVATE PARCELS.

1. AUTHORIZATION

THIS CONDITIONAL USE PERMIT AMENDMENT, CASE NO. 10-051-CUPAM (PERMIT), AUTHORIZES IMPLEMENTATION OF "JULY 12, 2010, DIRECTOR EXHIBIT #1" (ATTACHED TO THESE CONDITIONS OF APPROVAL) SUBJECT TO THESE CONDITIONS OF APPROVAL (PROJECT). ALL CONSTRUCTION, IMPROVEMENTS, IMPLEMENTATION, AND/OR ANY OTHER ACTIONS TAKEN PURSUANT TO THIS PERMIT SHALL BE IN SUBSTANTIAL CONFORMANCE WITH THE PROJECT. ANY DEVIATIONS FROM THE PROJECT MUST BE REVIEWED AND APPROVED BY THE CITY OF GOLETA (CITY). THE CITY SHALL DETERMINE WHETHER ANY DEVIATION SUBSTANTIALLY CONFORMS TO THE PROJECT. ANY DEVIATION DETERMINED TO NOT BE IN SUBSTANTIAL CONFORMANCE WITH THE PROJECT REQUIRES THE PERMITTEE TO SEEK ADDITIONAL APPROVAL, PERMITS, OR OTHER ACTION BY THE CITY. ANY DEVIATION FROM THE PROJECT MADE WITHOUT THE ABOVE-DESCRIBED REVIEW AND APPROVAL OF THE CITY IS A VIOLATION OF THIS PERMIT.

2. AUTHORIZED DEVELOPMENT

CONDITIONAL USE PERMIT AMENDMENT 10-051-CUPAM AMENDS THE ORIGINAL CONDITIONAL USE PERMIT (09-039-CUP) IN THE FOLLOWING MANNER:

THE PROPOSED PROJECT INVOLVES THE MODIFICATION OF THREE EXISTING NODES AND THE ADDITION OF TWO NEW NODES TO THE EXISTING NEXTG NETWORKS RADIOFREQUENCY TRANSPORT SERVICE SYSTEM WITHIN THE CITY RIGHTS-OF-WAY (ROWS) AND UTILITY EASEMENTS OVER VARIOUS PUBLIC AND PRIVATE PROPERTIES CITY-WIDE. THE THREE EXISTING NODES ARE LOCATED AT THE FOLLOWING LOCATIONS: (1) CATHEDRAL OAKS RD./WHICHESTER CANYON RD.; (2) PHELPS RD./PACIFIC OAKS RD.; AND (3) CATHEDRAL OAKS RD./LOS CARRIPOS RD. THE TWO NODES WILL BE LOCATED AT: (1) HOLLISTER AVE./PATTERSON AVE.; (2) CAMBRIDGE DR./CATHEDRAL OAKS RD.

EACH NODE WILL INCLUDE AN OMNIDIRECTIONAL ANTENNA AND SUPPORTING EQUIPMENT CABINET BELOW THE ANTENNA MOUNTED ON AN EXISTING UTILITY POLE, TRAFFIC SIGNAL, OR STREET LIGHT. EACH NODE WILL BE CONNECTED BY FIBER-OPTIC CABLE INSTALLED EITHER ON EXISTING UTILITY POLES, IN JOINT CONDUIT, OR THROUGH SHALLOW TRENCHING WITHIN CITY STREETS. SUPPORT EQUIPMENT FOR EACH NODE WILL BE INSTALLED AT A MINIMUM HEIGHT ABOVE EXISTING GRADE OF NINE (9) FEET, OR UNDERGROUND. ALL ANTENNAE AND SUPPORTING EQUIPMENT WOULD BE NON-REFLECTIVE IN COLOR AND MATERIALS. THE ELECTRICAL POWER SUPPLY FOR EACH NODE WOULD BE PROVIDED FROM EXISTING UTILITY LINES INSTALLED ON EITHER EXISTING UTILITY POLES OR IN JOINT CONDUIT. NO NEW UTILITY POLES FOR THE SUPPLY OF ELECTRICAL POWER TO ANY OF THE NODES ARE PROPOSED.

CONDITIONS REQUIRED PRIOR TO LAND USE PERMIT APPROVAL

3. PRIOR TO ISSUANCE OF ANY LAND USE PERMIT (LUP) TO EFFECTUATE THIS PERMIT, THE PERMITTEE SHALL OBTAIN DESIGN REVIEW BOARD (DRB) PRELIMINARY AND FINAL APPROVAL FOR THE PROJECT. PLANS SUBMITTED TO THE DRB FOR PRELIMINARY/FINAL REVIEW SHALL INCLUDE SPECIFICATIONS FOR THE COLOR OF ALL EQUIPMENT CABINETS AND ANTENNAE SUPPORT FACILITIES THAT MATCH TO THE MAXIMUM EXTENT FEASIBLE THE COLOR OF THE MOUNTING POLE.
4. PRIOR TO ISSUANCE OF THE LUP EFFECTUATING THIS PERMIT, THE PERMITTEE SHALL ENTER INTO A FRANCHISE AGREEMENT WITH THE CITY FOR USE OF ONE TRAFFIC SIGNAL POLE FOR NODE MOUNTING PURPOSES AT THE INTERSECTION OF CATHEDRAL OAKS ROAD AND WHICHESTER CANYON ROAD (NODE GOLN001). VIOLATION OF ANY OF THE TERMS OF THE FRANCHISE AGREEMENT AT ANY TIME SHALL BE CONSIDERED GROUNDS FOR THE CITY TO HOLD HEARINGS ON REMEDIAL ACTION, INCLUDING REVOCATION OF THE CUP FOR CAUSE.
5. PRIOR TO THE ISSUANCE OF ANY LUP TO EFFECTUATE THE PROJECT, THE PERMITTEE SHALL PAY IN FULL ALL APPLICABLE PERMIT PROCESSING FEES.
6. PRIOR TO THE ISSUANCE OF ANY LUP TO EFFECTUATE THE PROJECT, THE PERMITTEE SHALL PAY IN FULL ALL APPLICABLE DEVELOPMENT FEES AS DETERMINED BY THE CITY. DEVELOPMENT IMPACT FEES IMPOSED SHALL BE THOSE IN EFFECT AT THE TIME OF ISSUANCE OF THE LUP.
7. PRIOR TO THE ISSUANCE OF ANY EFFECTUATING LUP, THE PERMITTEE SHALL PROVIDE THE CITY WITH AN EASEMENT ANALYSIS FOR EACH PRIVATE AND/OR PUBLIC PARCEL OVER WHICH THE PROJECT FACILITIES SHALL BE INSTALLED THAT VERIFIES THAT THE APPLICANT HAS THE RIGHT TO USE SUCH EASEMENT FOR THE INSTALLATION OF SUCH FACILITIES.

GENERAL CONDITIONS

8. ABOVE-GROUND MOUNTED SUPPORT EQUIPMENT FOR THE NODES SHALL NOT BE ALLOWED. ALL SUPPORT EQUIPMENT FOR OPERATION OF THE NODES SHALL BE MOUNTED ON THE UTILITY POLE AT LEAST NINE (9) FEET ABOVE GRADE ON THE POLE OR PLACED UNDERGROUND.
9. ALL EQUIPMENT AND CONDUIT ATTACHED TO THE UTILITY POLE SHALL BE PAINTED THE SAME COLOR AS THE EXISTING POLE, WITH THE EXCEPTION OF THE ANTENNA ITSELF.
10. THE PERMITTEE SHALL OBTAIN FROM THE CITY'S PLANNING AND ENVIRONMENTAL SERVICES DEPARTMENT A LAND USE PERMIT PRIOR TO COMMENCEMENT OF ANY USES AND /OR DEVELOPMENT AUTHORIZED BY THIS PERMIT.
11. THE PERMITTEE SHALL OBTAIN FROM THE CITY'S PLANNING AND ENVIRONMENTAL SERVICES DEPARTMENT ALL BUILDING PERMITS REQUIRED BY THE TITLE 15 OF THE GOLETA MUNICIPAL CODE PRIOR TO THE CONSTRUCTION, ERECTION, MOVING, ALTERATION, ENLARGING, REBUILDING OF ANY BUILDING, STRUCTURE, OR IMPROVEMENT, OR ANY OTHER ACTION(S) REQUIRING A BUILDING PERMIT PURSUANT TO TITLE 15 OF THE GOLETA MUNICIPAL CODE.
12. THESE CONDITIONS OF APPROVAL SHALL BE PRINTED IN THEIR ENTIRETY ON ALL PLANS SUBMITTED FOR ISSUANCE OF ANY LUP OR BUILDING PERMIT FOR THE PROJECT.
13. IF USE OF THE PROJECT IS DISCONTINUED FOR A PERIOD OF MORE THAN ONE YEAR, THE FACILITY SHALL BE CONSIDERED ABANDONED. UNLESS THE PERIOD IS EXTENDED IN THE TIME AND MANNER PERMITTED BY THE CITY MUNICIPAL CODE, ALL COMPONENTS OF THE PROJECT SHALL BE REMOVED FROM THE SITE. THE PROJECT AREA SHALL BE RESTORED TO ITS PRE-FACILITY STATE, PROVIDED FURTHER THAT THE LANDOWNER MAY REQUEST THAT THE FACILITY REMAIN AND OBTAINS THE NECESSARY PERMITS. ALL REQUIRED REMOVAL OF COMPONENTS AND FACILITY RESTORATION SHALL BE COMPLETED WITHIN 180 DAYS OF THE DATE OF RECEIPT OF THE CITY'S NOTICE TO ABATE. CITY STAFF SHALL CONDUCT A SITE INSPECTION 180 DAYS AFTER ISSUANCE OF A NOTICE TO ABATE TO ENSURE COMPLIANCE WITH THIS CONDITION. IF THE PERMITTEE COMPLETES ALL NECESSARY ABANDONMENT AND RESTORATION ACTIVITIES BEFORE THE END OF THE 180-DAY PERIOD, THE PERMITTEE MAY CONTACT THE CITY TO ARRANGE FOR A SITE COMPLIANCE INSPECTION PRIOR TO THE END OF THE 180-DAY PERIOD.
14. THIS PERMIT SHALL EXPIRE 18 MONTHS AFTER THE APPROVAL DATE, UNLESS WITHIN SUCH PERIOD SUBSTANTIAL PHYSICAL CONSTRUCTION OF THE PROJECT HAS BEEN COMPLETED OR A TIME EXTENSION HAS BEEN APPLIED FOR BY THE PERMITTEE. THE APPROVING DECISION-MAKER OF THE PROJECT MAY, UPON GOOD CAUSE SHOWN, GRANT A TIME EXTENSION FOR ONE (1) YEAR. IN THE EVENT THAT A REQUEST FOR A TIME EXTENSION IS MADE BY THE PERMITTEE, THESE CONDITIONS OF APPROVAL MAY BE REVISED AND/OR ADDITIONAL CONDITIONS OF APPROVAL MAY BE IMPOSED IF DETERMINED NECESSARY BY THE CITY.
15. THIS PERMIT RUNS WITH THE LAND AND THE RIGHTS AND OBLIGATIONS THEREOF, INCLUDING THE RESPONSIBILITY TO COMPLY WITH THESE CONDITIONS OF APPROVAL AND SHALL BE BINDING UPON SUCCESSORS IN INTEREST UNLESS OR UNTIL THIS PERMIT EXPIRES PURSUANT TO CONDITION OF APPROVAL #14 OR IS EXPRESSLY ABANDONED IN WRITING BY THE PERMITTEE.
16. THIS PERMIT IS GRANTED FOR THE PROPERTY/PARCEL(S) OF RECORD ON WHICH THE PROJECT IS LOCATED AND SHALL NOT BE TRANSFERRED.
17. VIOLATION OF ANY OF THESE CONDITIONS OF APPROVAL IS UNLAWFUL, PROHIBITED AND A VIOLATION OF THE GOLETA MUNICIPAL CODE. THE CITY PRESERVES THE RIGHT TO INITIATE CIVIL, CRIMINAL AND/OR ADMINISTRATIVE ENFORCEMENT, OR AFTER NOTICE AND A PUBLIC HEARING, TO REVOKE THIS PERMIT OR MODIFY THESE CONDITIONS OF APPROVAL IF IT IS FOUND THAT THERE IS A VIOLATION OF THESE CONDITIONS OF APPROVAL OR THAT THE PROJECT OPERATES AS OR CAUSES A PUBLIC NUISANCE. THIS CONDITION OF APPROVAL IS NOT INTENDED TO, NOR DOES IT LIMIT IN ANY MANNER WHATSOEVER THE ABILITY OF THE CITY TO TAKE APPROPRIATE ENFORCEMENT ACTIONS.
18. THE PERMITTEE SHALL BE RESPONSIBLE FOR THE COMPLETENESS AND ACCURACY OF ALL FORMS AND SUPPORTING MATERIALS SUBMITTED IN CONNECTION WITH THE PROJECT. ANY ERRORS OR DISCREPANCIES FOUND THEREIN ARE A VIOLATION OF THIS PERMIT.
19. ANY NEW, EXPANDED, OR CHANGED USE ON THE PROJECT SITE SHALL BE SUBJECT TO CITY REVIEW AND APPROVAL. THE CITY SHALL DETERMINE WHETHER THE NEW, EXPANDED, OR CHANGED USE ON THE PROJECT SITE REQUIRES THE PERMITTEE TO SEEK ADDITIONAL APPROVAL, PERMITS, OR OTHER ACTION BY THE CITY. FAILURE OF THE PERMITTEE TO OBTAIN THE ABOVE-DESCRIBED REVIEW AND APPROVAL OF THE CITY IS VIOLATION OF THIS PERMIT.
20. THE PERMITTEE SHALL, AT APPLICANT'S EXPENSE, DEFEND, INDEMNIFY, AND HOLD HARMLESS THE CITY AND ITS AGENTS, OFFICERS, AND EMPLOYEES FROM ANY CLAIM, ACTION, OR PROCEEDING AGAINST THE CITY OF ITS AGENTS, OFFICERS, OR EMPLOYEES TO ATTACK, REVIEW, SET ASIDE, VOID, OR ANNUL, IN WHOLE OR IN PART, THE CITY APPROVAL OF THIS PERMIT OR ANY CONDITION ATTACHED HERETO OR ANY PROCEEDINGS, ACTS, OR DETERMINATIONS TAKEN, DONE, OR MADE PRIOR TO THE APPROVAL OF THIS PERMIT THAT WERE PART OF THE APPROVAL PROCESS.
21. IN THE EVENT THAT ANY CONDITION OF APPROVAL IMPOSING A FEE, EXACTION, DEDICATION OR OTHER MITIGATION MEASURE IS CHALLENGED BY THE PERMITTEE IN AN ACTION FILED IN A COURT OF LAW OR THREATENED TO BE FILED THEREIN WHICH ACTION IS BROUGHT WITHIN THE TIME PERIOD PROVIDED BY LAW, THIS PERMIT SHALL BE SUSPENDED PENDING DISMISSAL OF SUCH ACTION, OR FINAL RESOLUTION OF SUCH ACTION. IF ANY CONDITION OF APPROVAL IS INVALIDATED BY A COURT OF LAW, THE PROJECT SHALL BE REVIEWED BY THE CITY AND SUBSTITUTE CONDITIONS OF APPROVAL MAY BE IMPOSED.
22. A NUMBER OF CONDITIONS OF APPROVAL ASSOCIATED WITH THE APPROVAL OF THE INITIAL CONDITIONAL USE PERMIT (09-039-CUP) APPLY TO THIS PROJECT. THE CONDITIONS OF APPROVAL FOR THE FOREMENTIONED CASES ARE HEREIN INCORPORATED BY REFERENCE AND ARE STILL APPLICABLE.



PROJECT INFORMATION:  
**MPC1035CA-GOLN002**  
**GOLETA**  
**GOLETA, CA 93117**

CURRENT ISSUE DATE:  
**08/08/2010**

PERMIT SUBMISSION:  
 \_\_\_\_\_

REV. DATE	DESCRIPTION	BY

PLANS PREPARED BY:  
**HP COMMUNICATIONS**  
**INC.**  
 5720 THORNWOOD DR.  
 GOLETA, CA 93117  
 PHONE: (551) 471-1919

PLANS APPROVED BY:  
  
 REP: \_\_\_\_\_

COMMENTS:  
 \_\_\_\_\_  
 \_\_\_\_\_  
 \_\_\_\_\_

SHEET TITLE:  
**NOTES**

SHEET NUMBER: **2** REVISION: **2 OF 6**



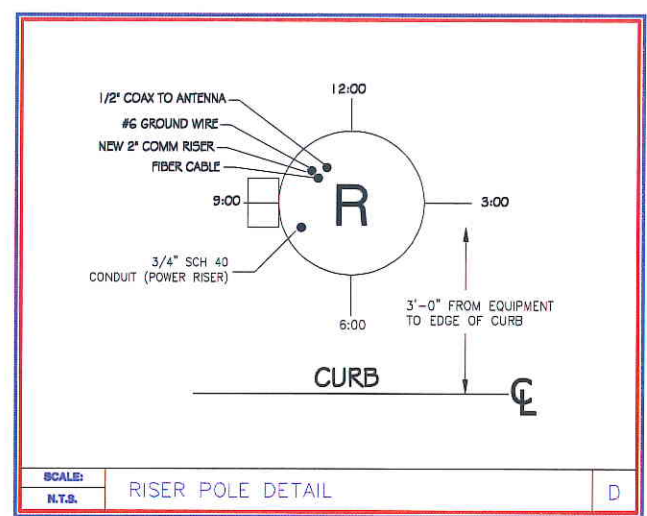
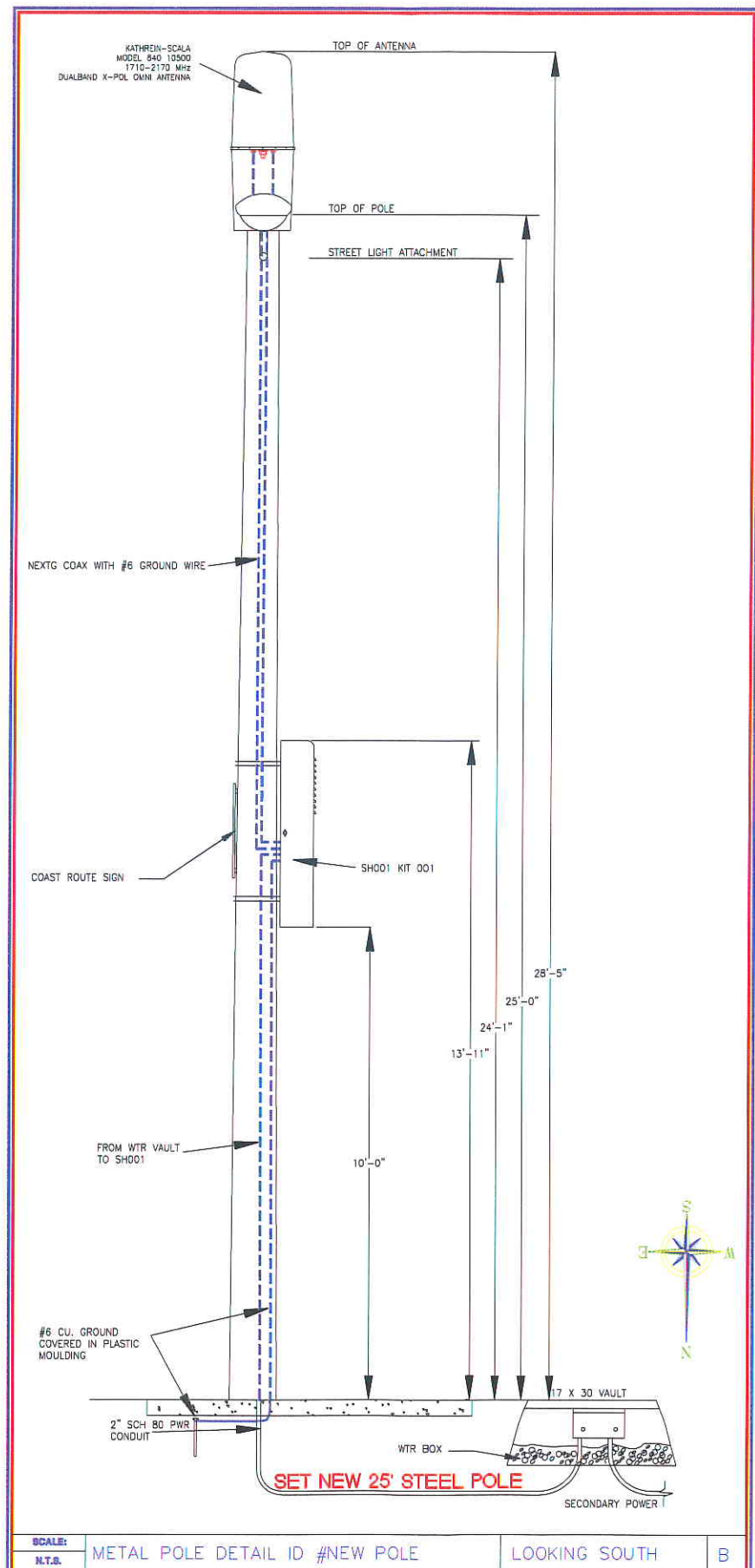
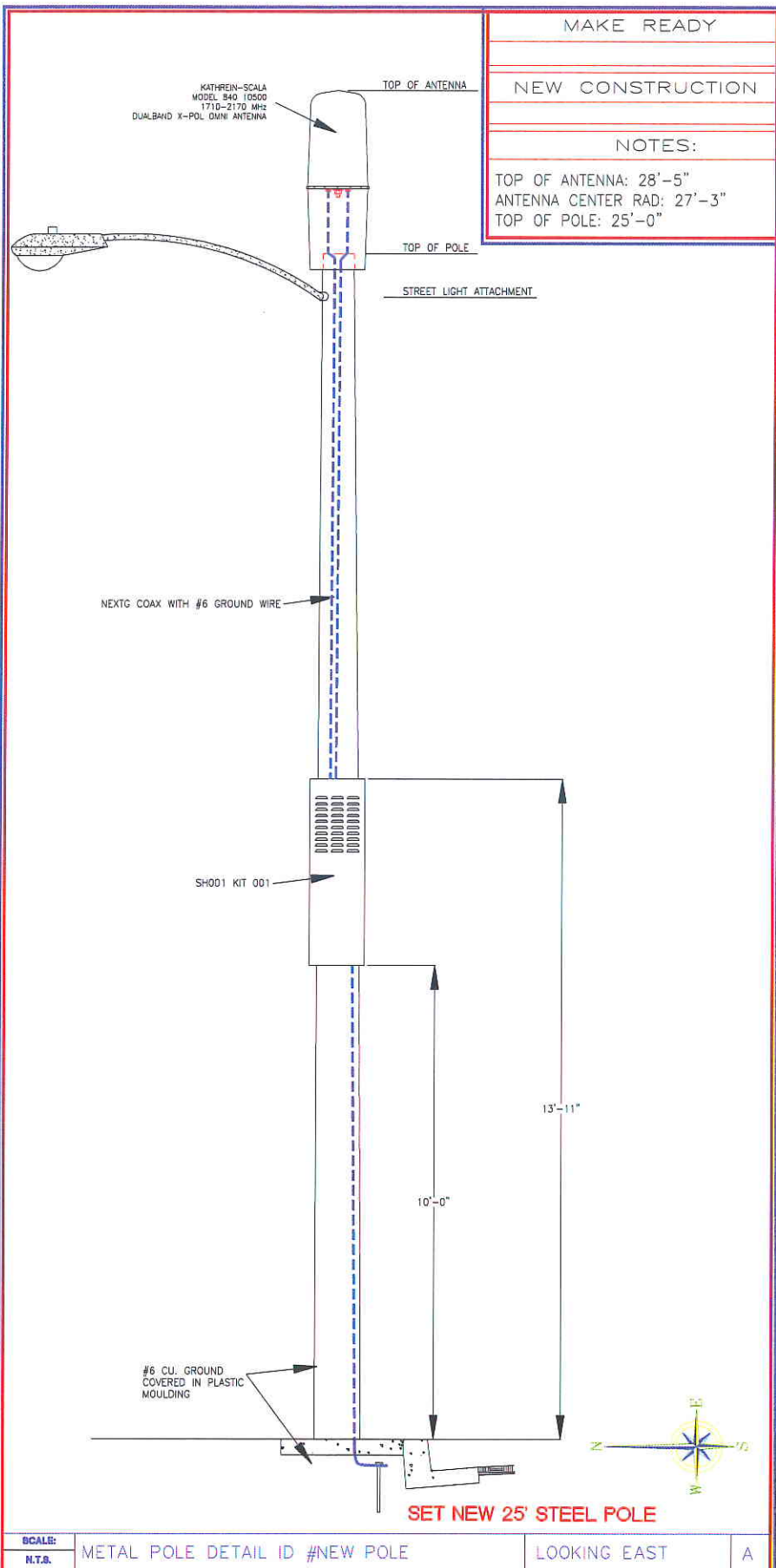

**DIGALERT**



1-800-227-2600  
 CALL AT LEAST TWO DAYS BEFORE YOU DIG

UNDERGROUND SERVICE ALERT OF NORTHERN CALIFORNIA

TICKET # \_\_\_\_\_



PROJECT INFORMATION:

MPC1035CA-GOLN002  
 GOLETA  
 GOLETA, CA 93117

CURRENT ISSUE DATE:

08/08/2010

PERMIT SUBMISSION:

REV.: DATE: DESCRIPTION: BY:

REV.	DATE	DESCRIPTION	BY

PLANS PREPARED BY:

HP COMMUNICATIONS INC.

5720 THORNWOOD DR.  
 GOLETA, CA 93117  
 PHONE: (951) 471-1919

PLANS APPROVED BY:



REP:

COMMENTS:

SHEET TITLE:

**PROFILES**

SHEET NUMBER: REVISION:

**3**

**3 OF 6**



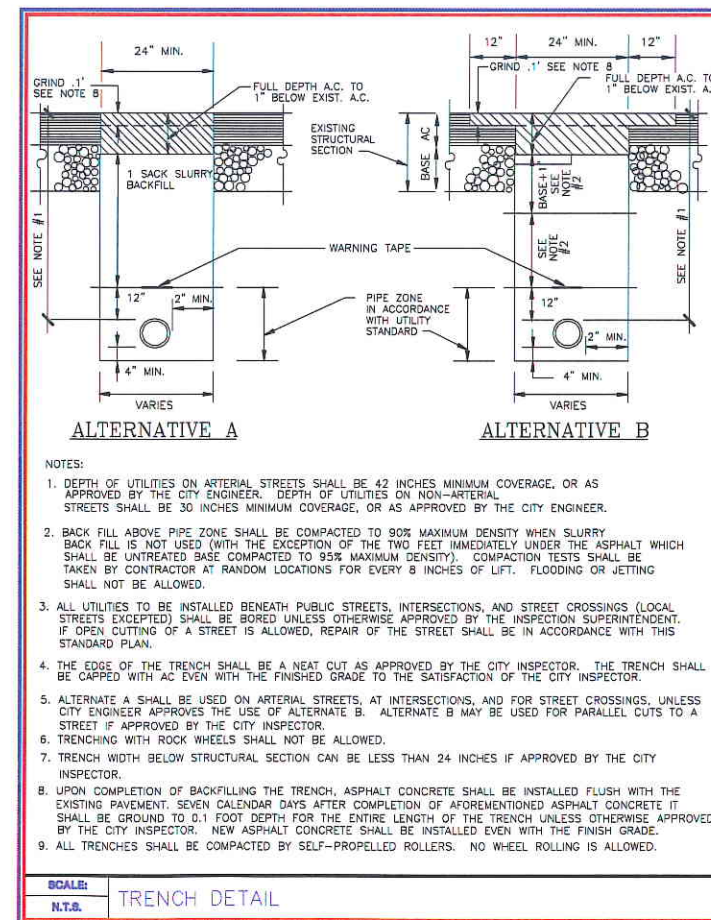
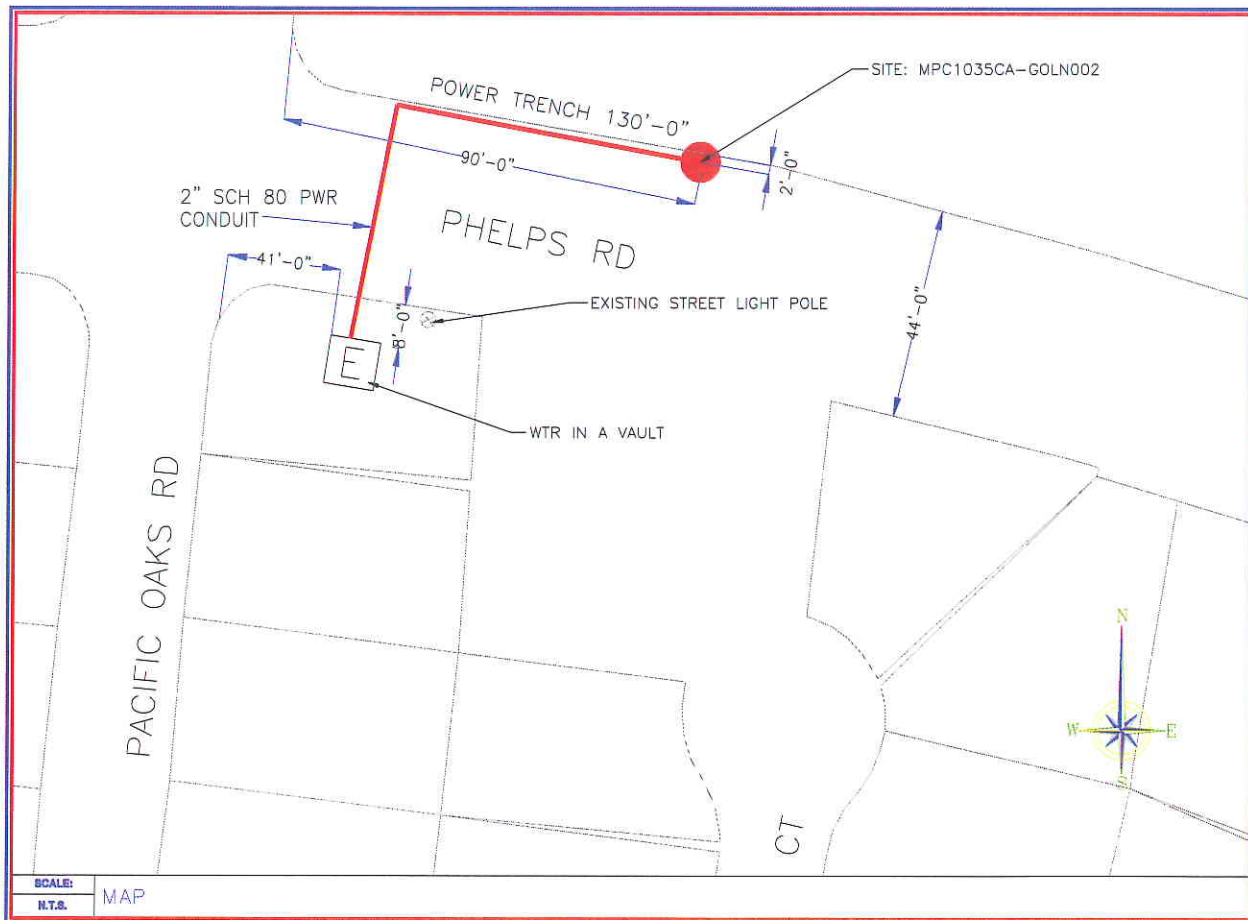
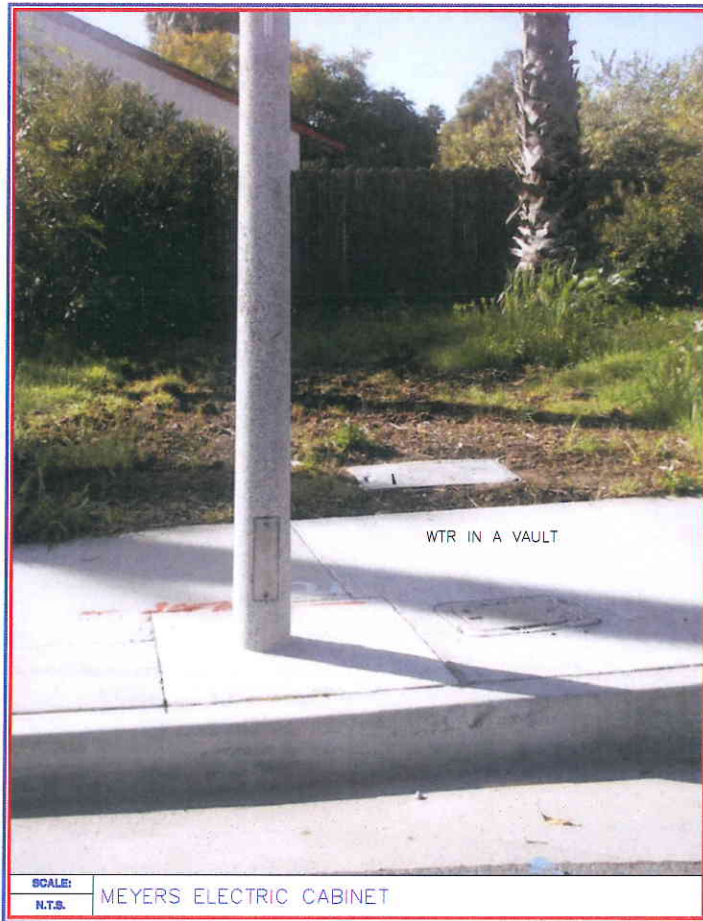

PROJECT INFORMATION:

MPC1035CA-GOLN002  
GOLETA  
GOLETA, CA 93117

CURRENT ISSUE DATE:

08/08/2010

PERMIT SUBMISSION:

REV.: DATE: DESCRIPTION: BY:

REV.	DATE	DESCRIPTION	BY

PLANS PREPARED BY:

HP COMMUNICATIONS INC.

5720 THORNWOOD DR.  
GOLETA, CA 93117  
PHONE: (951) 471-1919

PLANS APPROVED BY:



REP:

COMMENTS:

SHEET TITLE:

MAP

SHEET NUMBER: REVISION:

4 4 OF 6



DUALBAND X-POL OMNI ANTENNA  
840 10500

GENERAL SPECIFICATIONS:

FREQUENCY RANGE:	806-960 MHz 1710-2170 MHz
GAIN:	8 dBi (WITH 3-5 dB NULLS, TYPICAL) 8 dBi (WITH 6-8 dB NULLS, TYPICAL)
VSWR:	<1.5:1
IMPEDANCE:	50 OHMS
INTERMODULATION (2x20w)	M3: <-150 dBc
POLARIZATION:	+45° UPPER AND LOWER BAND -45° UPPER AND LOWER BAND
CONNECTOR:	2 x 7/16 DIN FEMALE
ISOLATION: INTRASYSTEM INTERSYSTEM	>30 dB >40 dB (806-960//1710-2170 MHz)
MAXIMUM INPUT POWER: 806-960 MHz 1710-2170 MHz	250 WATTS (AT 50°C) 200 WATTS (AT 50°C)
RADOME COLOR:	LIGHT GRAY (CUSTOM COLORS AVAILABLE AT ADDITIONAL COST)
WEIGHT:	45 LB. (20.4 kg)
HEIGHT:	24.2 INCHES (615 mm)
RADOME DIAMETER:	18.3 INCHES (465 mm)
EQUIVALENT FLAT PLATE AREA:	1.6 FT <sup>2</sup> (0.148 m <sup>2</sup> )
WIND SURVIVAL RATING:	100 mph (160 kph)
SHIPPING DIMENSIONS:	32 x 20 x 19 INCHES (813 x 508 x 483 mm)
SHIPPING WEIGHT:	52 lbs. (23.6 kg)
MOUNTING:	DESIGNED TO BE MOUNTED ON TOP OF A UTILITY POLE USING A CUSTOM MOUNTING BRACKET SUPPLIED BY THE CUSTOMER.

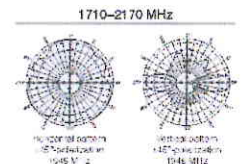
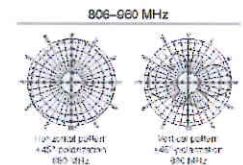

SCALE: ANTENNA SPECIFICATIONS  
N.T.S.

A

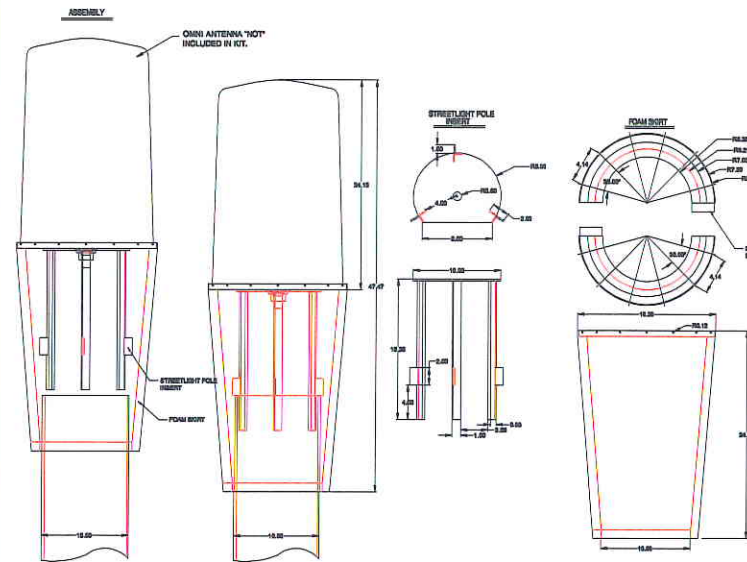

SCALE: ANTENNA INSTALLATION KIT  
N.T.S.

B

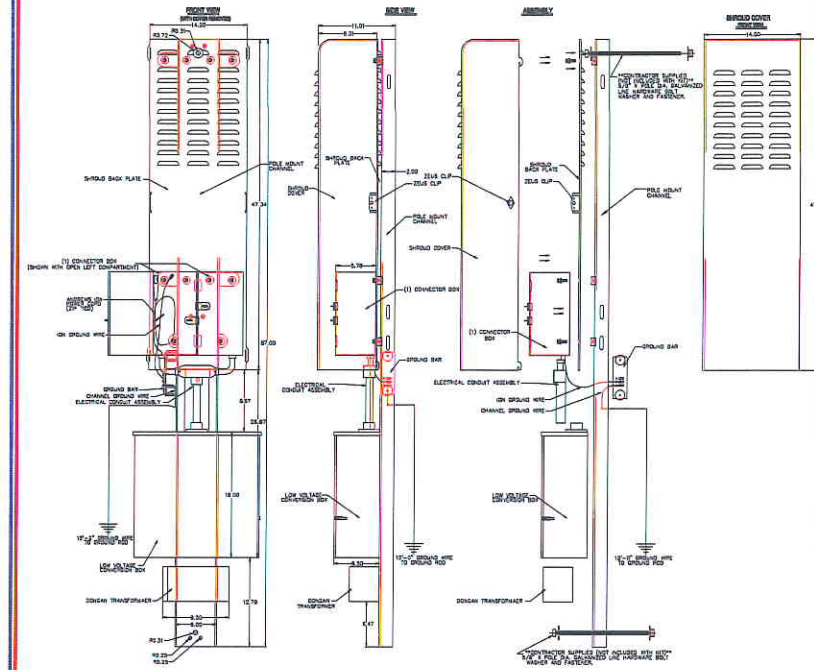

SCALE: SHROUD SPECIFICATIONS (SH001)  
N.T.S.

C

ION-M19P  
ANDREW ION-M19P IS A MULTI-BAND MULTI-OPERATOR REMOTE UNIT WITH VARIOUS EXTENSION UNITS.  
IT IS USED IN CONJUNCTION WITH A MASTER UNIT IN THE ION OPTICAL DISTRIBUTION SYSTEM.  
THIS SYSTEM TRANSPORTS MULTIPLE FREQUENCY BANDS SIMULTANEOUSLY (1900 MHz AND 1700/2100 MHz),  
PROVIDING A COST-EFFECTIVE SOLUTION FOR DISTRIBUTING CAPACITY FROM ONE OR MORE BASE STATIONS.

ELECTRICAL POWER SUPPLY	85 TO 264	INPUT ICP	ICP3 OPTIMIZED	-12
MAINS POWER, VAC	115 OR 230	NOISE FIGURE, DB	ICP3 OPTIMIZED	-18
POWER CONSUMPTION, WATTS	350	NOISE FIGURE, DB	ICP3 OPTIMIZED	11
OPTICAL CONNECTORS	E2000/APC 8'	NOISE FIGURE, DB	ICP3 OPTIMIZED	6
OPTICAL RETURN LOSS, DB	45 MINIMUM	FREQUENCY RANGE, MHZ	1700/2100 MHZ (N EXTENSION UNIT)	
FIBER TYPE, MM	SINGLE MODE E9/125	UPLINK	210 TO 1755	
OPTICAL LINK BUDGET, DB	0 TO 10	DOWNLINK	1710 TO 2155	
COMPOSITE INPUT POWER		OUTPUT POWER PER CARRIER, DBM	WCDMA/EV-DO	+43
Ø OTHER MASTER SIG, DBM			WCDMA/HSPA	+43
1900MHZ	+3 COMPOSITE		WCDMA/HSPA	+40
1700/2100 MHZ	+5 COMPOSITE		WCDMA/HSPA	+37
INTERFACE			WCDMA/HSPA	+34
BTS SIDE			SPURIOUS EMISSION	< -13 DBM / 1 MHZ
NUMBER OF CONNECTORS	4		ADJACENT CHANNEL POWER, DBC	-48
1900MHZ			DL OUTPUT TOLERANCE OVER FREQ, DB	+1
1700/2100 MHZ			DL OUTPUT TOLERANCE OVER TEMP, DB	+0.5
SYSTEM OPTIMIZED FOR BTS POWER, DBM	33		INPUT ICP3, DBM	
ANTENNA PORT CONNECTOR	N FEMALE		ICP3 OPTIMIZED	-12
CONNECTOR	SEE BAND SPECIFICATION		NOISE FIGURE OPTIMIZED	-18
OUTPUT POWER			** APPLICABLE TO SINGLE MODULATION MODE ONLY	
1900 MHZ			** WITH ACTIVE COOLING	
FREQUENCY RANGE, MHZ				
UPLINK	1850 TO 1915			
DOWNLINK	1930 TO 1995			
OUTPUT POWER PER CARRIER, DBM				
NUMBER OF CARRIERS	1 2 4 8			
OSM	43 40 37 34			
TOMA/ EDGE	43 40 37 34			
CDMA/EV-DO	43 40 37 34			
WCDMA/HSPA	43 40 37 34			
SPURIOUS EMISSION	<-13 DBM / 1MHZ			
DL OUTPUT TOLERANCE OVER FREQUENCY, DB	+1			
DL OUTPUT TOLERANCE OVER TEMPERATURE, DB	+0.5			

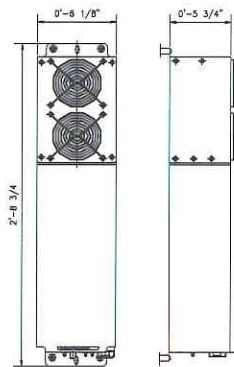

SCALE: REPEATER EQUIPMENT DIMENSIONS  
N.T.S.

D

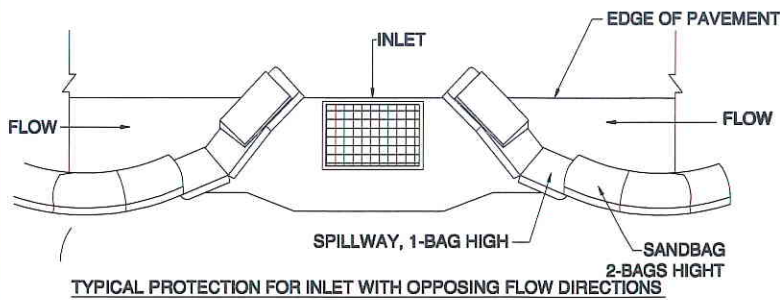

TYPICAL PROTECTION FOR INLET WITH OPPOSING FLOW DIRECTIONS

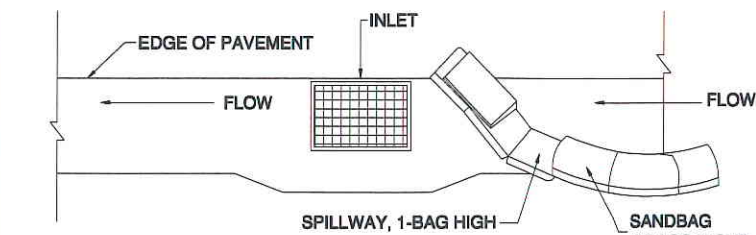

TYPICAL PROTECTION FOR INLET WITH SINGLE FLOW DIRECTION

- NOTES:
1. INTENDED FOR SHORT-TERM USE.
  2. USE TO INHIBIT NON-STORM WATER FLOW.
  3. ALLOW FOR PROPER MAINTENANCE AND CLEANUP.
  4. BAGS MUST BE REMOVED AFTER ADJACENT OPERATION IS COMPLETED.
  5. NOT APPLICABLE IN AREAS WITH HIGH SILTS AND CLAYS WITHOUT FILTER FABRIC.

SCALE: STORM DRAIN INLET PROTECTION  
N.T.S.

E

- COVER FEATURES:
- \* PW - 10,400 LBS. WHEEL LOAD ON 10" x 10" PLATE
  - \* APPROX. WT. = 72 LBS.
  - \* POLYMER CONCRETE
  - \* ONE PIECE COVER
  - \* FOUR BOLT DOWN
  - \* COLOR: CONCRETE GREY
  - \* NON - SKID SURFACE

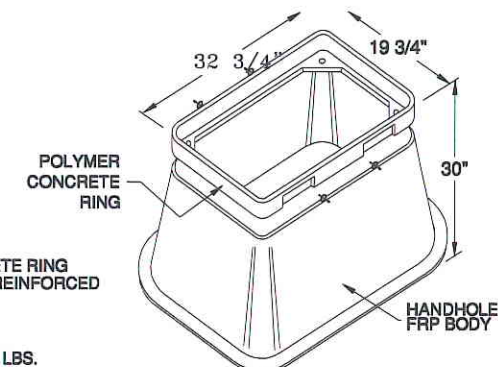
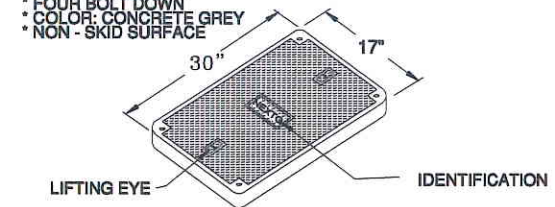

- VAULT FEATURES:
- \* POLYMER CONCRETE RING AND FIBERGLASS REINFORCED POLYMER BODY
  - \* COLOR OF RING: CONCRETE GREY
  - \* APPROX. WT. = 123 LBS.

SCALE: 17" X 30" CONNECTOR HANDHOLE  
N.T.S.

F

PROJECT INFORMATION:

**MPC1035CA-GOLN002**  
**GOLETA**  
**GOLETA, CA 93117**

CURRENT ISSUE DATE:

**08/08/2010**

PERMIT SUBMISSION:

REV.: DATE: DESCRIPTION: BY:

REV.	DATE	DESCRIPTION	BY

PLANS PREPARED BY:

**HP COMMUNICATIONS INC.**

5720 THORNWOOD DR.  
GOLETA, CA 93117  
PHONE: (851) 471-1919

PLANS APPROVED BY:

REP:

COMMENTS:

SHEET TITLE:

**TYPICALS PAGE 1**

SHEET NUMBER: REVISION:

**5**

**5 OF 6**



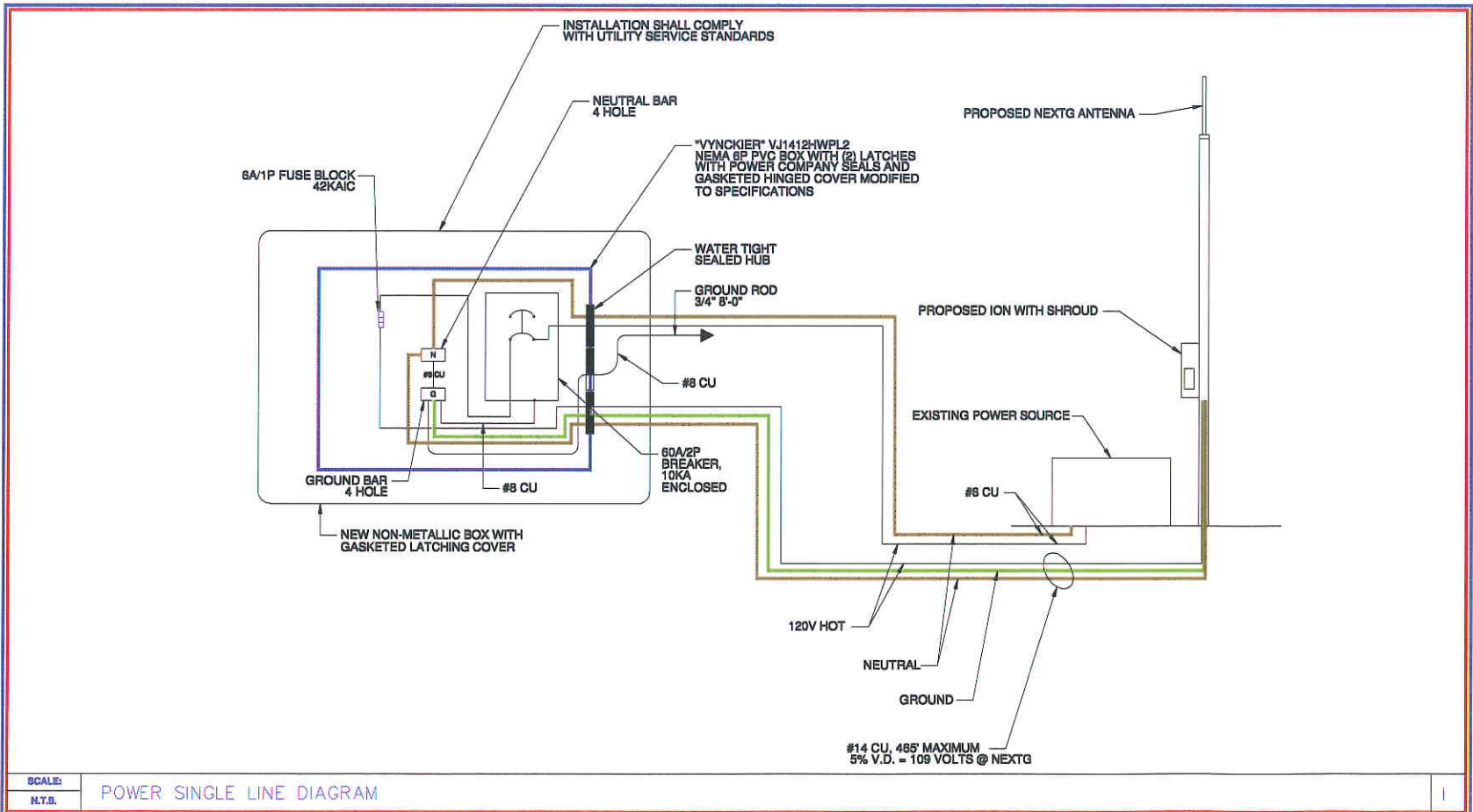
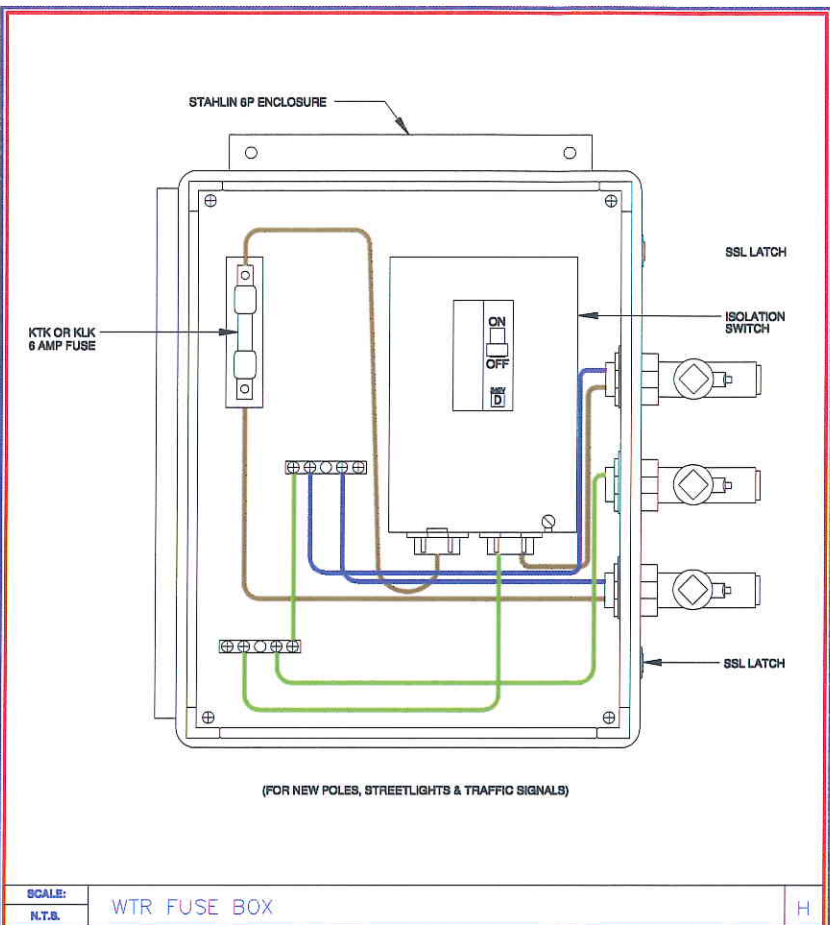
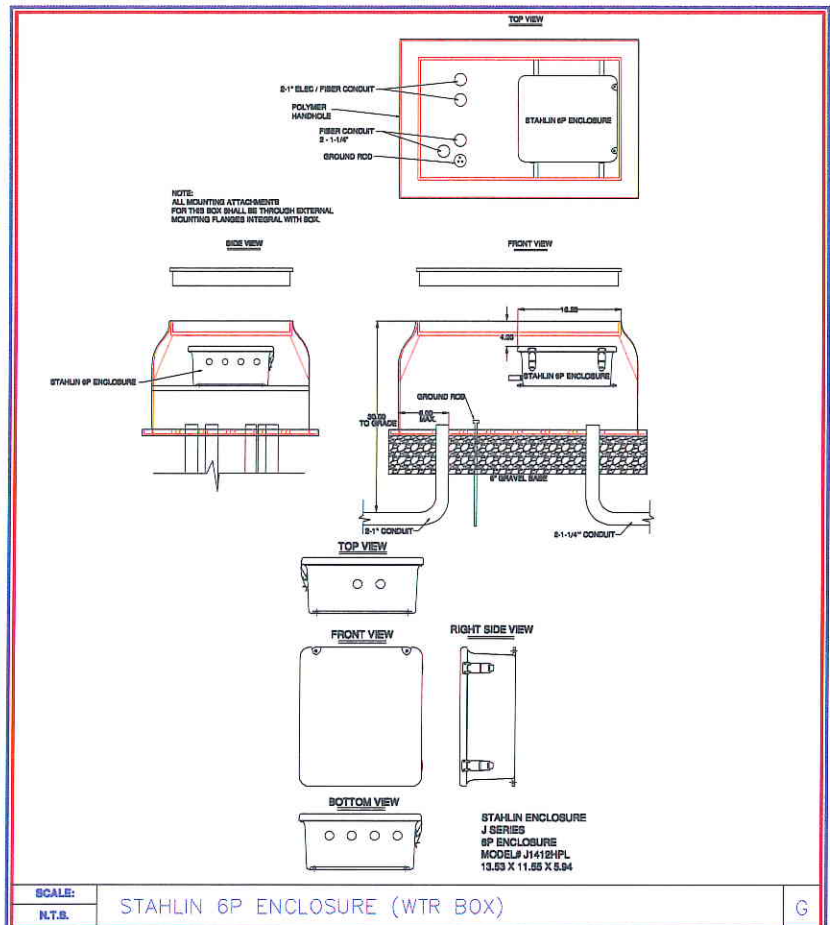

PROJECT INFORMATION:  
**MPC1035CA-GOLN002**  
**GOLETA**  
**GOLETA, CA 93117**

CURRENT ISSUE DATE:  
**08/08/2010**

PERMIT SUBMISSION:  
 REV.: DATE: DESCRIPTION: BY:

REV.	DATE	DESCRIPTION	BY

PLANS PREPARED BY:  
**HP COMMUNICATIONS INC.**  
 5720 THORNWOOD DR.  
 GOLETA, CA 93117  
 PHONE: (851) 471-1919

PLANS APPROVED BY:  
**NextG Networks of California, Inc.**  
 REP:

COMMENTS:

SHEET TITLE:  
**TYPICALS PAGE 2**

SHEET NUMBER: **6** REVISION:  
**6 OF 6**